

# MULTIZONE PRODUCT INFORMATION

## CFCC3200-3M

Multizone "C" Tank  
 (3" Stainless MPT Inlet Standard)  
 Includes 3 Circuit Outlet Manifold  
 Ball Valves & Hardware Included  
 3 Circuits - 2 Dual - 1 Single 26-116 230V Pumps (Single Speed Pumps)

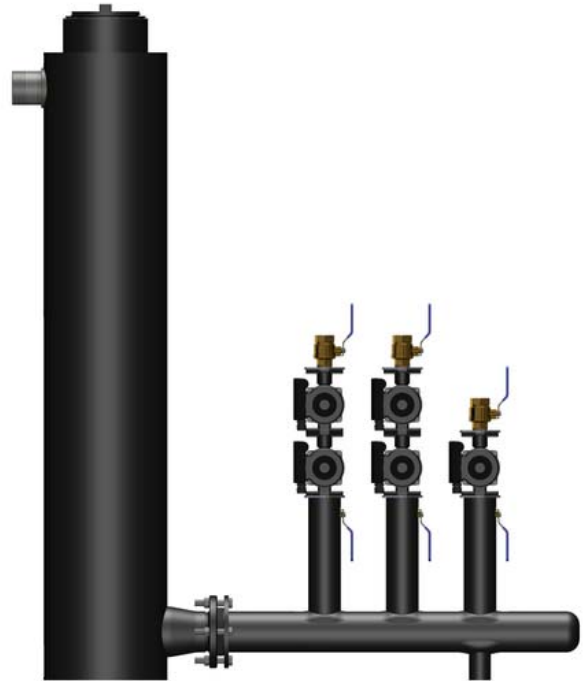

NOTE: Multizone image above is of actual product after field assembly.

## Dimensional Data

NOTE: Multizone image below is shown without pumps for dimensional reference only.

